

TRUE BLUE PRODUCTS

TRUE CLIP & GIRT WITH GIRT WIRE

REV: 1



TBP
TRUE BLUE PRODUCTS

Main Office
3530 E Atlanta Ave.
Phoenix, AZ 85040
West Coast Distribution
4750 Caterpillar Rd. Suite E
Redding, CA 96003
PH: 602-581-5299
www.trueblueproducts.net

DWG:

TITLE PAGE

DWG NO:

T

SCALE: N.T.S. REV: 1

DRAWN BY: RD REV DATE: 10.8.20

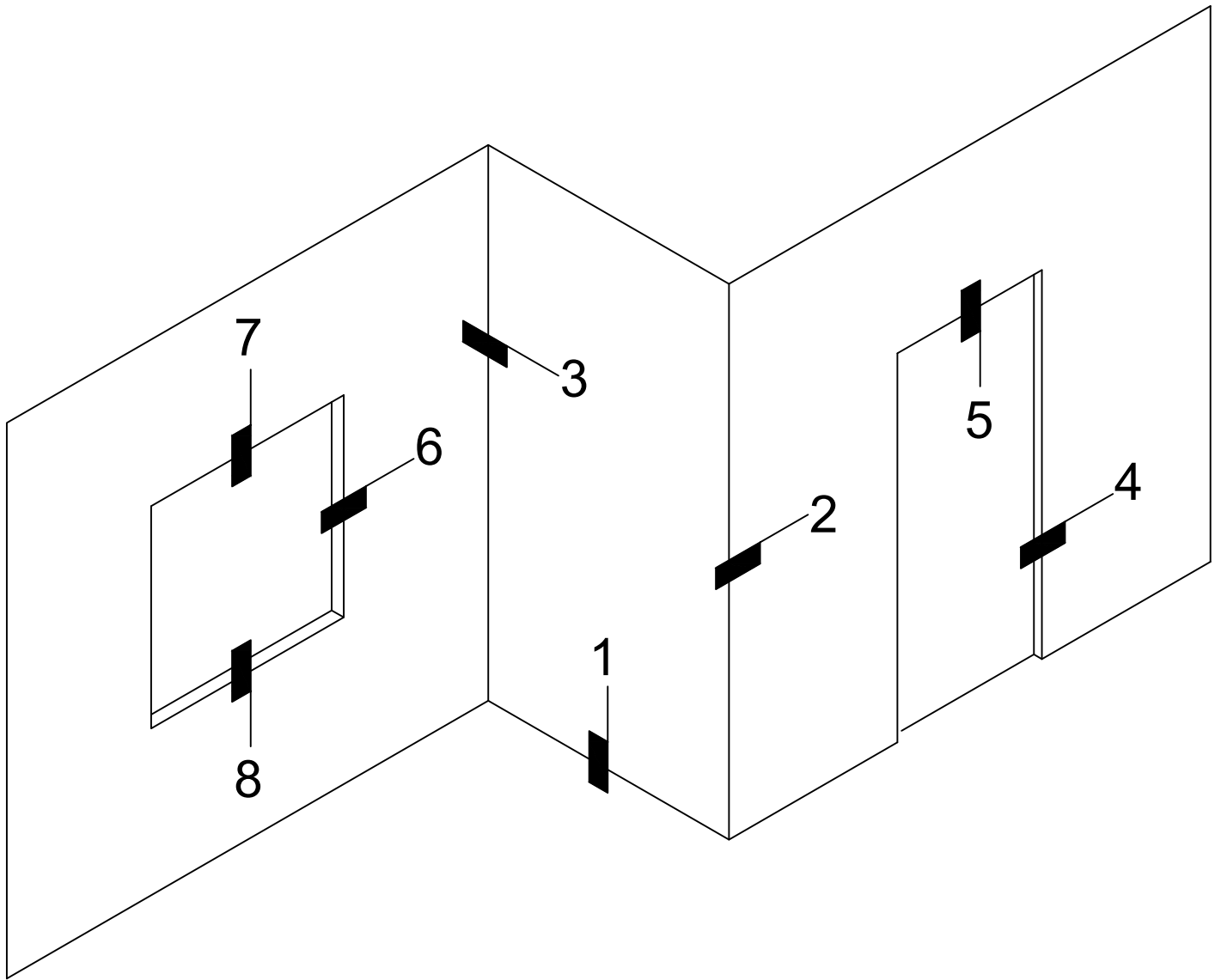

TBP
TRUE BLUE PRODUCTS

Main Office
 3530 E Atlanta Ave.
 Phoenix, AZ 85040
 West Coast Distribution
 4750 Caterpillar Rd. Suite E
 Redding, CA 96003
 PH: 602-581-5299
www.trueblueproducts.net

DWG:

ELEVATION

DWG NO:

E

SCALE: N.T.S. REV: 1

DRAWN BY: RD REV DATE: 10.8.20

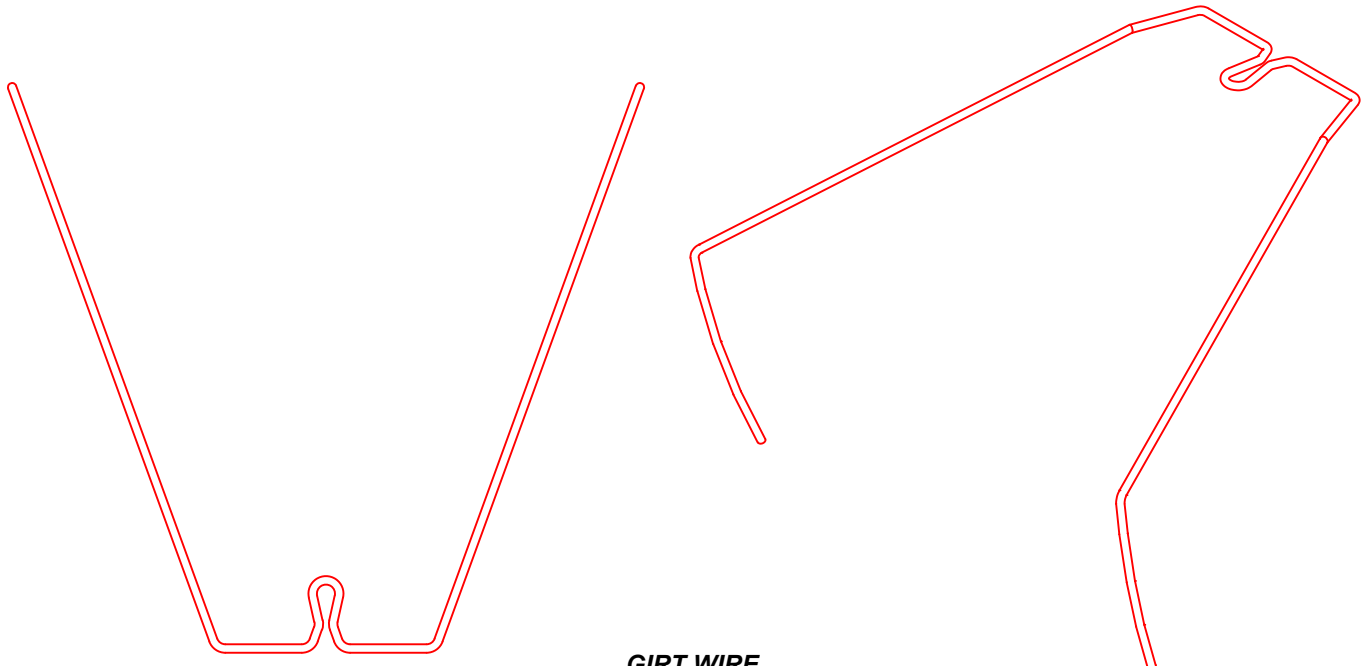

**GIRT WIRE
(GW-X)
X = WIRE SIZE**

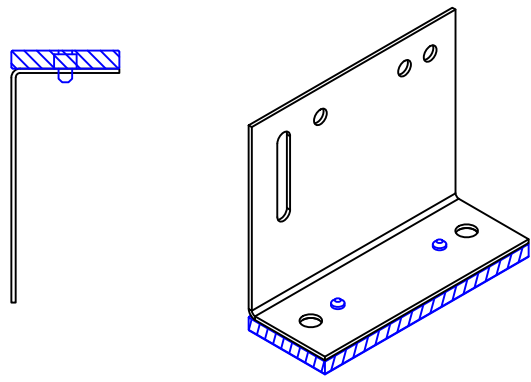

**TRUE CLIP WITH ISOLATOR
(TC-X)
X = CLIP SIZE**

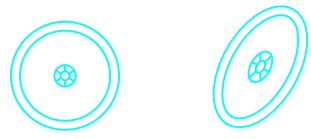

**FLAT WASHER
(FW-1)**



**TRUE GIRT
(TG-8)**

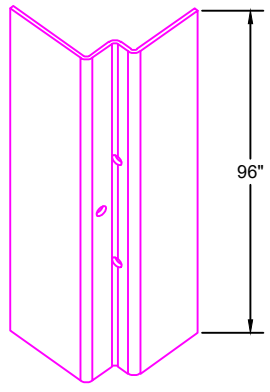

Main Office
3530 E Atlanta Ave.
Phoenix, AZ 85040
West Coast Distribution
4750 Caterpillar Rd. Suite E
Redding, CA 96003
PH: 602-581-5299
www.trueblueproducts.net

DWG: PARTS DIAGRAM		DWG NO: P
SCALE: N.T.S.	REV: 1	
DRAWN BY: RD	REV DATE: 10.8.20	

**FASTENERS SHOWN
NOT BY TBP**

INSULATION/
MINERAL WOOL
NOT BY **TBP**

FLAT WASHER
(2 PER GIRT WIRE)

TRUE GIRT
(PLUMB & LEVEL)

GIRT WIRE

**TRUE CLIP WITH
ISOLATOR**

MEMBRANE
NOT BY **TBP**

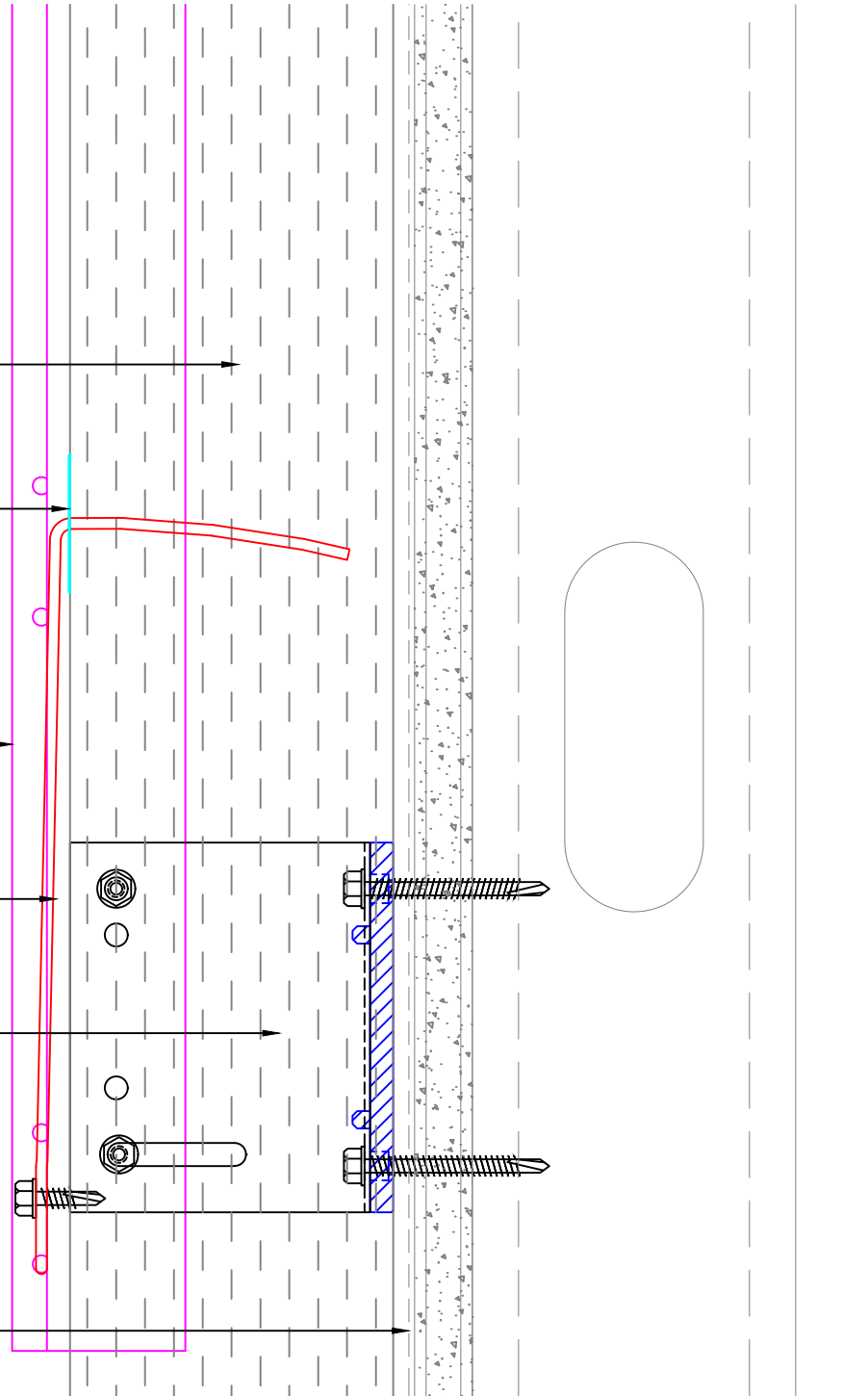

TBP
TRUE BLUE PRODUCTS

Main Office
3530 E Atlanta Ave.
Phoenix, AZ 85040
West Coast Distribution
4750 Caterpillar Rd. Suite E
Redding, CA 96003
PH: 602-581-5299
www.trueblueproducts.net

DWG:

BASE

DWG NO:

1

SCALE: N.T.S.

REV:

1

DRAWN BY: RD

REV DATE: 10.8.20

**FASTENERS SHOWN
NOT BY TBP**

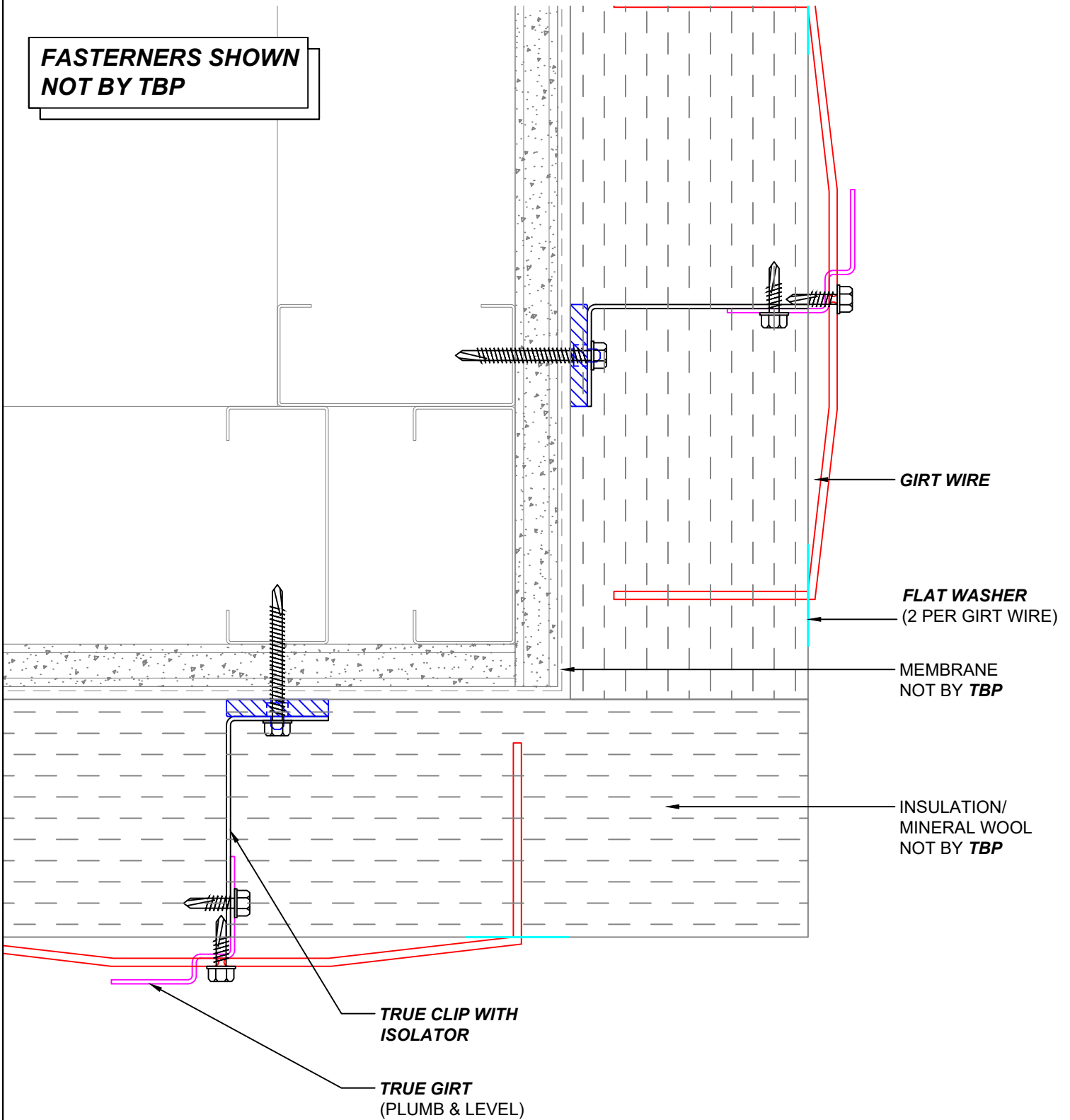

Main Office
3530 E Atlanta Ave.
Phoenix, AZ 85040
West Coast Distribution
4750 Caterpillar Rd. Suite E
Redding, CA 96003
PH: 602-581-5299
www.trueblueproducts.net

DWG:

OUTSIDE CORNER

DWG NO:

2

SCALE:	N.T.S.	REV:	1
DRAWN BY:	RD	REV DATE:	10.8.20

**FASTENERS SHOWN
NOT BY TBP**

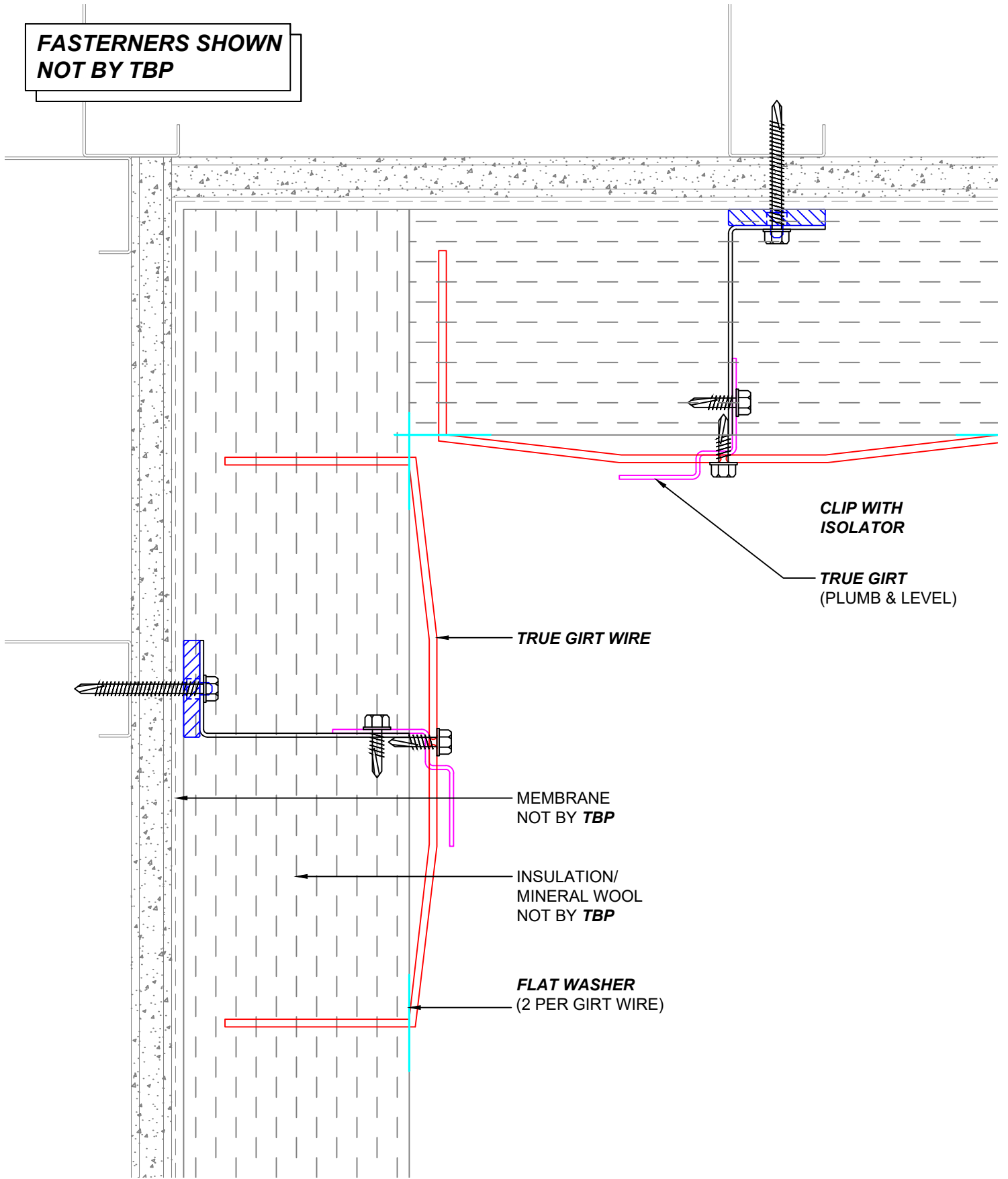

TBP
TRUE BLUE PRODUCTS

Main Office
3530 E Atlanta Ave.
Phoenix, AZ 85040
West Coast Distribution
4750 Caterpillar Rd. Suite E
Redding, CA 96003
PH: 602-581-5299
www.trueblueproducts.net

DWG:

INSIDE CORNER

DWG NO:

3

SCALE: N.T.S. REV: 1

DRAWN BY: RD REV DATE: 10.8.20

**FASTENERS SHOWN
NOT BY TBP**

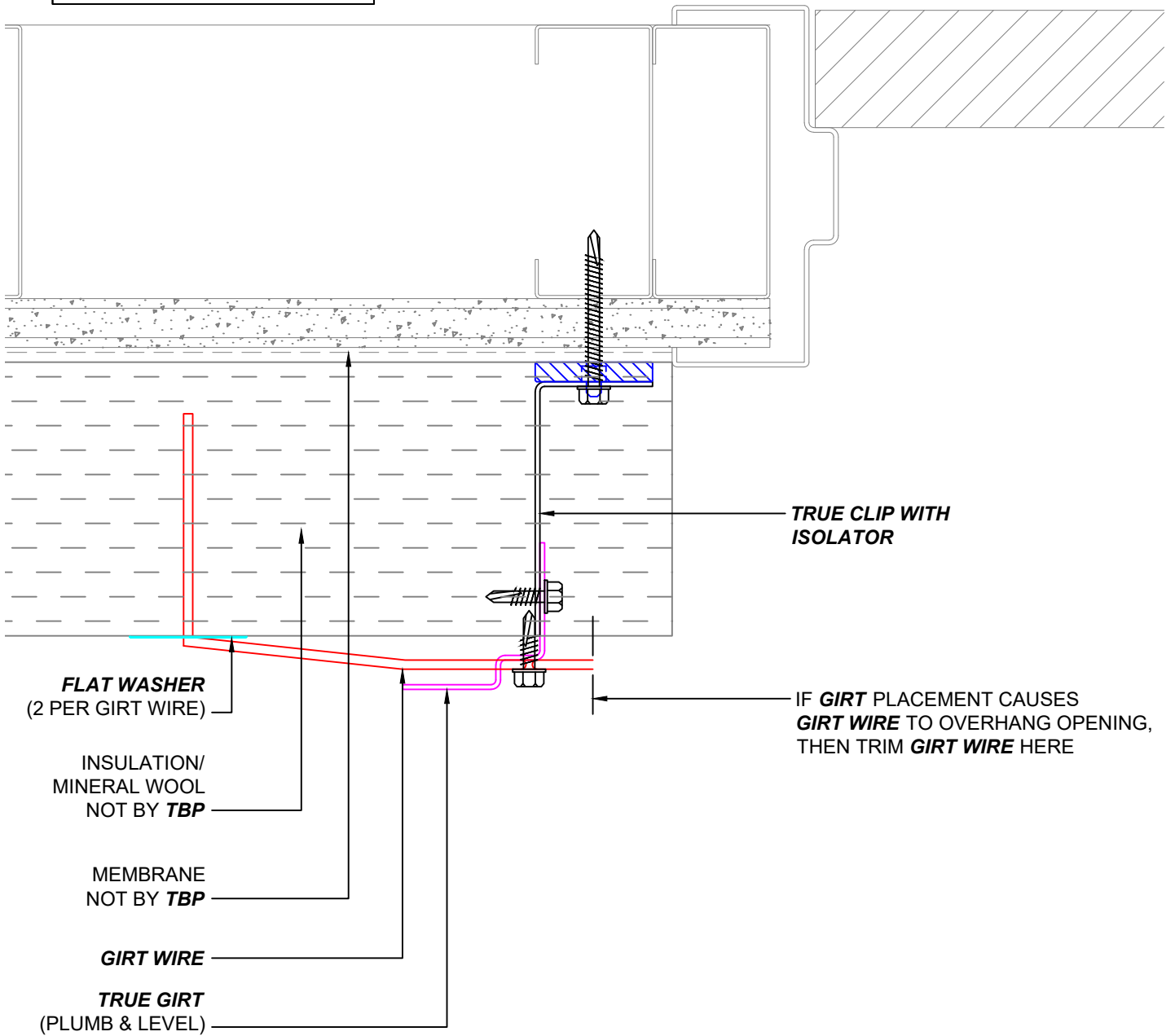

Main Office
3530 E Atlanta Ave.
Phoenix, AZ 85040
West Coast Distribution
4750 Caterpillar Rd. Suite E
Redding, CA 96003
PH: 602-581-5299
www.trueblueproducts.net

DWG:

DOOR JAMB

DWG NO:

4

SCALE:	N.T.S.	REV:	1
DRAWN BY:	RD	REV DATE:	10.8.20

**FASTENERS SHOWN
NOT BY TBP**

INSULATION/
MINERAL WOOL
NOT BY *TBP*

FLAT WASHER
(2 PER GIRT WIRE)

TRUE GIRT
(PLUMB & LEVEL)

GIRT WIRE

**CLIP WITH
ISOLATOR**

MEMBRANE
NOT BY *TBP*

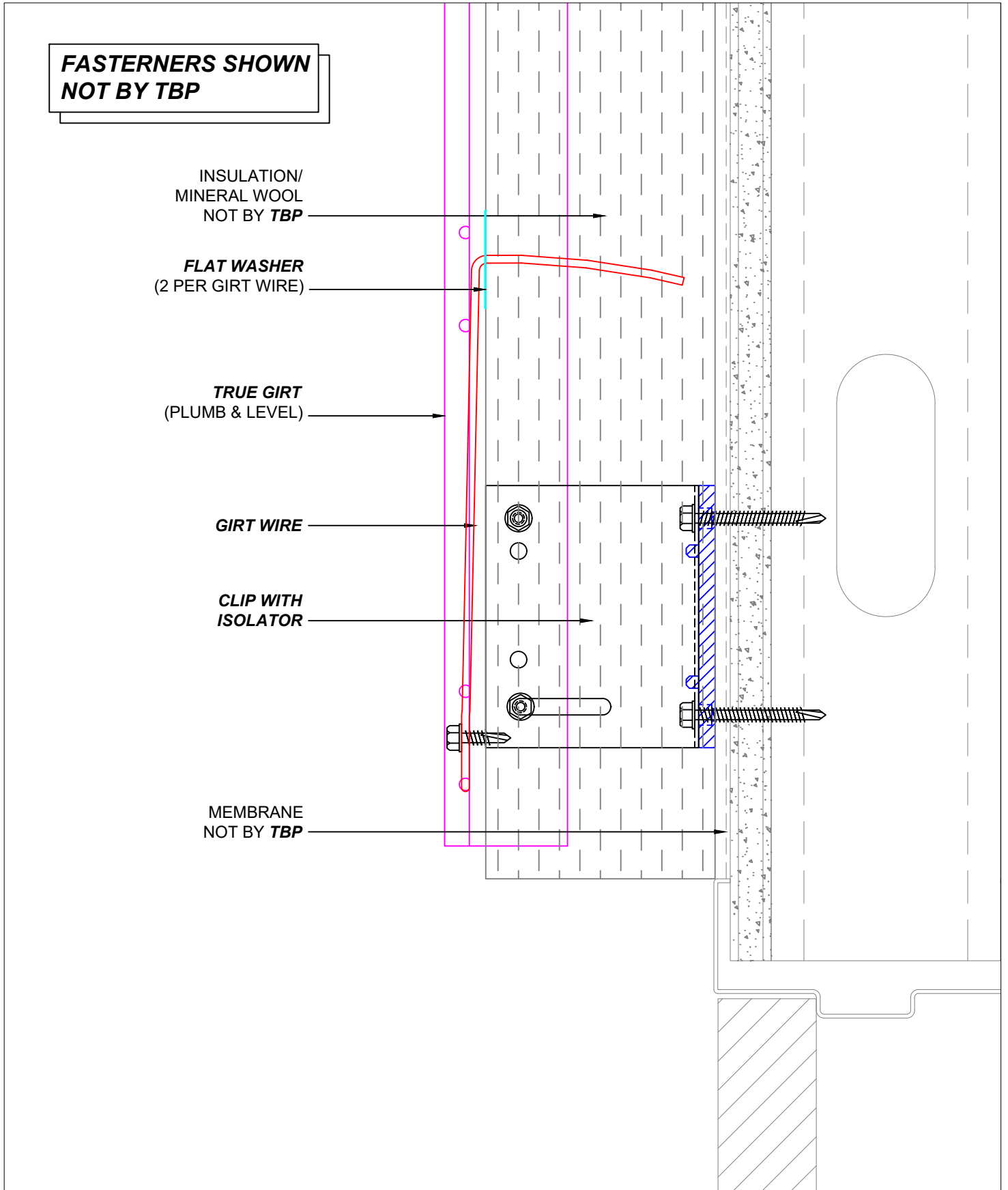

TBP
TRUE BLUE PRODUCTS

Main Office
3530 E Atlanta Ave.
Phoenix, AZ 85040
West Coast Distribution
4750 Caterpillar Rd. Suite E
Redding, CA 96003
PH: 602-581-5299
www.trueblueproducts.net

DWG:

DOOR HEADER

DWG NO:

5

SCALE:	N.T.S.	REV:	1
DRAWN BY:	RD	REV DATE:	10.8.20

**FASTENERS SHOWN
NOT BY TBP**

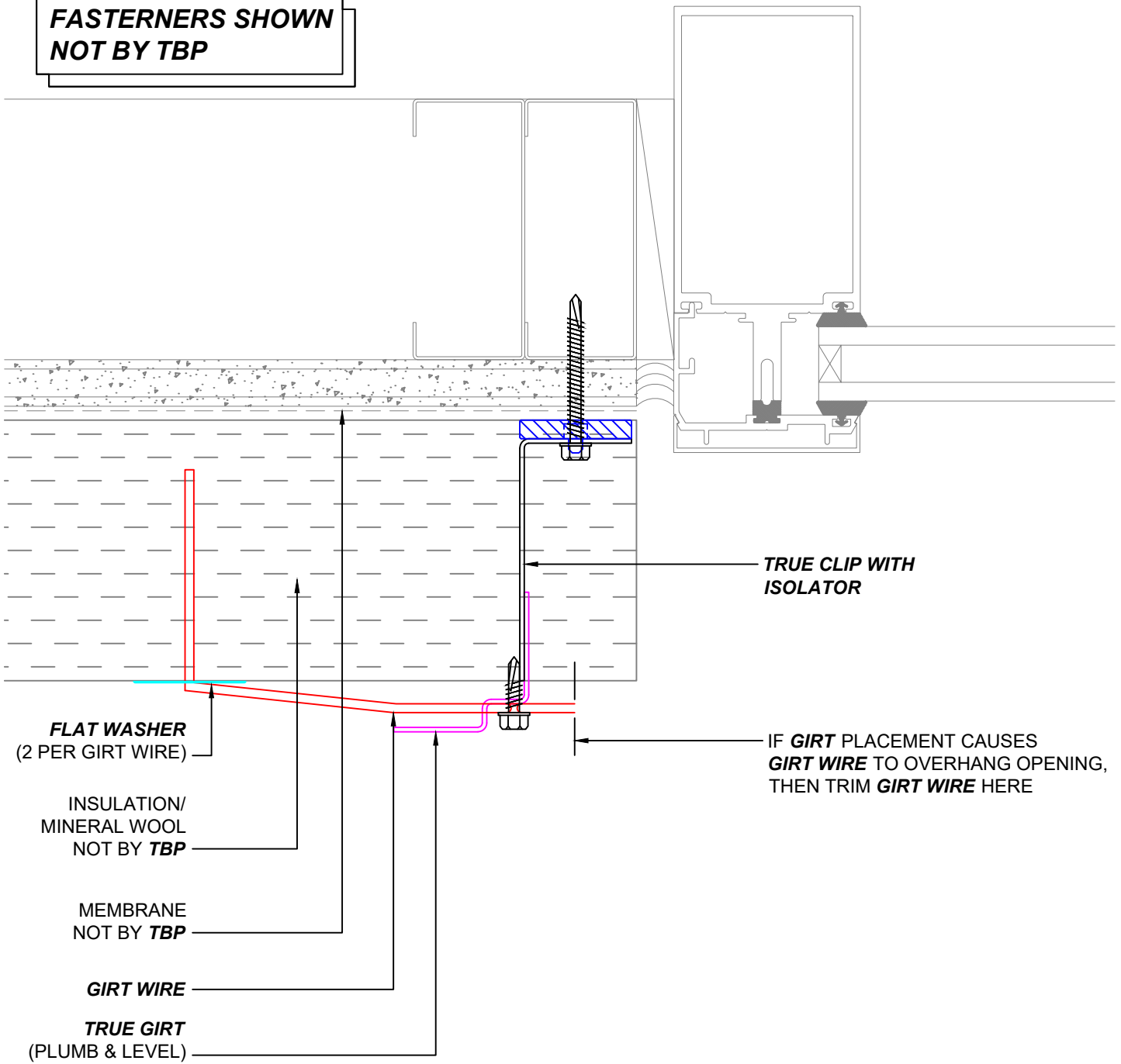

**FLAT WASHER
(2 PER GIRT WIRE)**

**INSULATION/
MINERAL WOOL
NOT BY TBP**

**MEMBRANE
NOT BY TBP**

GIRT WIRE

**TRUE GIRT
(PLUMB & LEVEL)**

**TRUE CLIP WITH
ISOLATOR**

**IF GIRT PLACEMENT CAUSES
GIRT WIRE TO OVERHANG OPENING,
THEN TRIM GIRT WIRE HERE**



Main Office
3530 E Atlanta Ave.
Phoenix, AZ 85040
West Coast Distribution
4750 Caterpillar Rd. Suite E
Redding, CA 96003
PH: 602-581-5299
www.trueblueproducts.net

DWG: WINDOW JAMB		DWG NO: 6
SCALE: N.T.S.	REV: 1	
DRAWN BY: RD	REV DATE: 10.8.20	

**FASTENERS SHOWN
NOT BY TBP**

**FLAT WASHER
(2 PER GIRT WIRE)**

**INSULATION/
MINERAL WOOL
NOT BY TBP**

**TRUE GIRT
(PLUMB & LEVEL)**

GIRT WIRE

**TRUE CLIP WITH
ISOLATOR**

**MEMBRANE
NOT BY TBP**

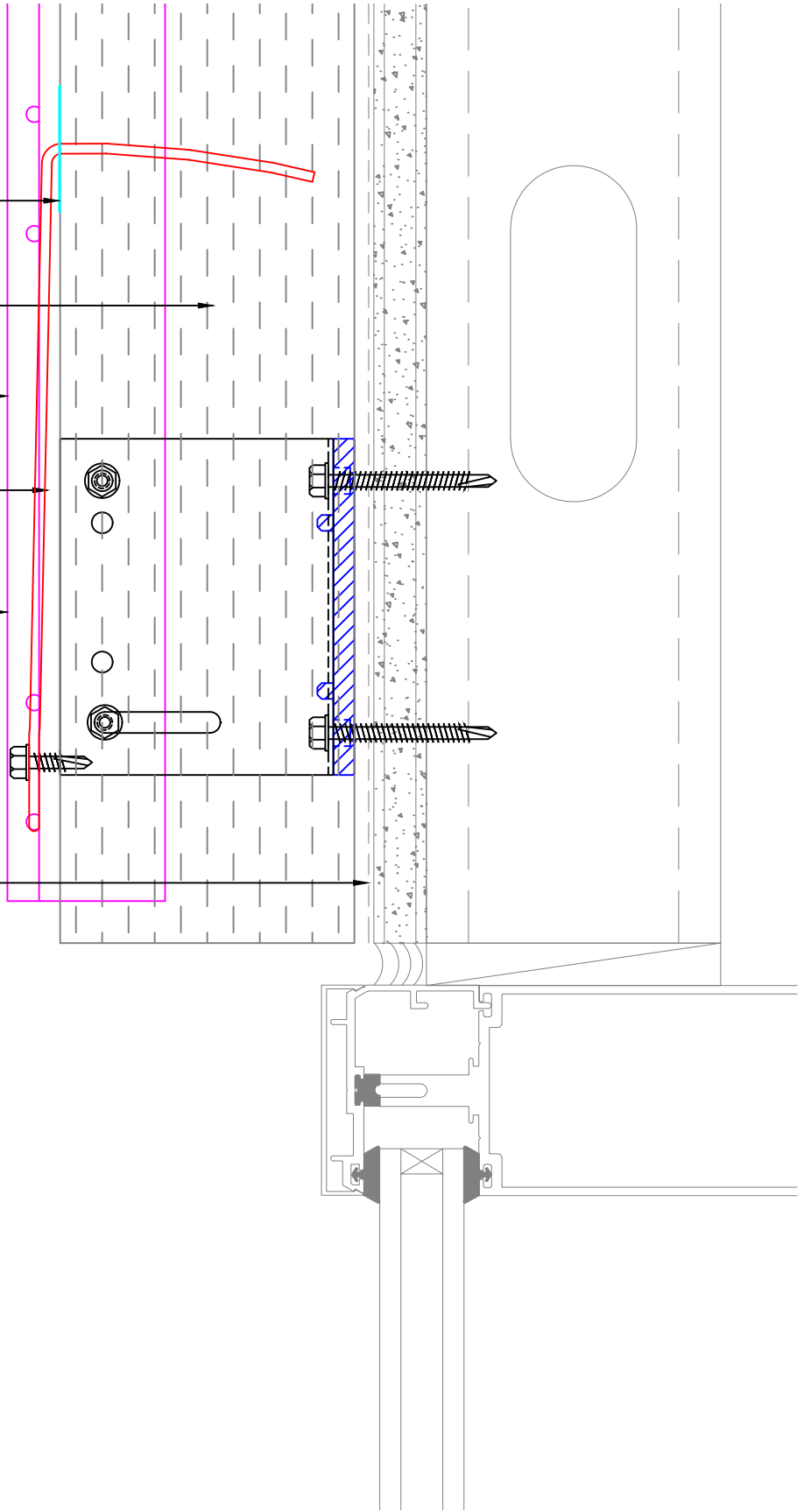

TBP
TRUE BLUE PRODUCTS

Main Office
3530 E Atlanta Ave.
Phoenix, AZ 85040
West Coast Distribution
4750 Caterpillar Rd. Suite E
Redding, CA 96003
PH: 602-581-5299
www.trueblueproducts.net

DWG:

WINDOW HEADER

DWG NO:

7

SCALE:	N.T.S.	REV:	1
DRAWN BY:	RD	REV DATE:	10.8.20

**FASTENERS SHOWN
NOT BY TBP**

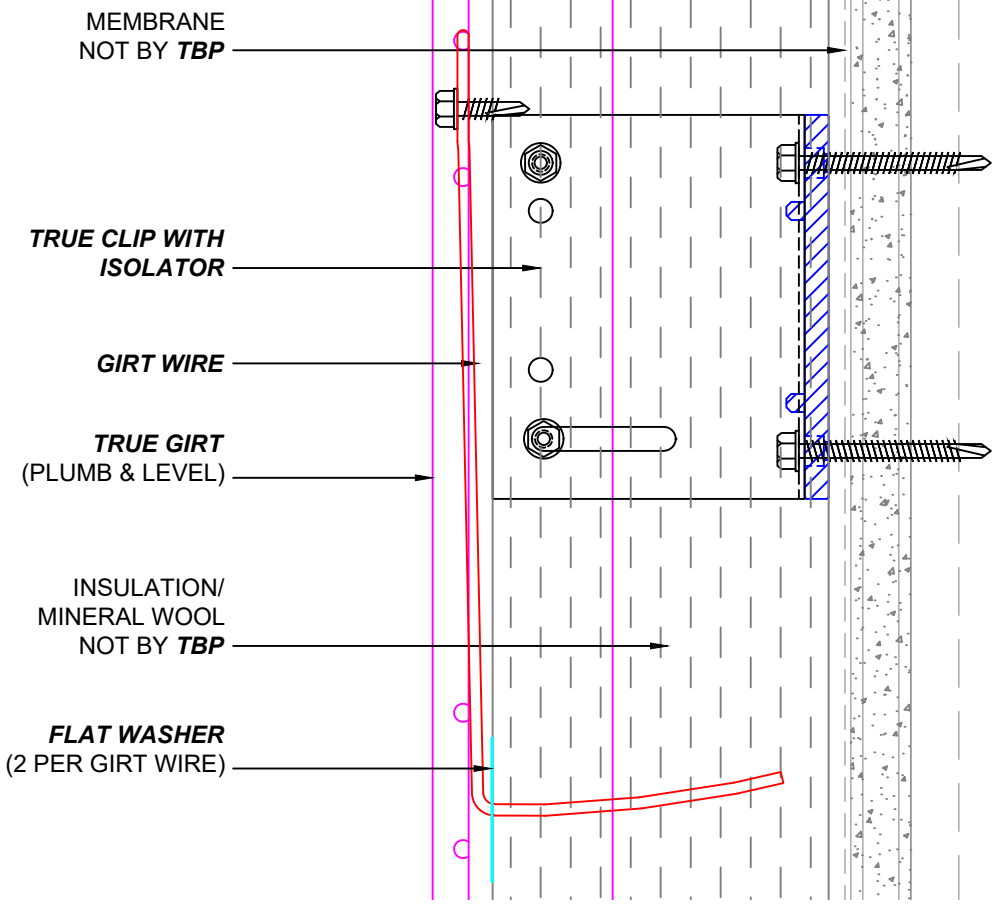

Main Office
3530 E Atlanta Ave.
Phoenix, AZ 85040
West Coast Distribution
4750 Caterpillar Rd. Suite E
Redding, CA 96003
PH: 602-581-5299
www.trueblueproducts.net

DWG:		WINDOW SILL		DWG NO:	8
SCALE:	N.T.S.	REV:	1		
DRAWN BY:	RD	REV DATE:	10.8.20		